



Volvo Trucks. Driving Progress

# VOLVO FH

PRODUCT GUIDE - EURO 3-5





## The truck of the future is now even more capable.

They say you shouldn't change a winning concept. Yet that's what we do all the time. We keep on introducing new features that add to the driving comfort, fuel efficiency and safety, and make the truck even more useful for many more applications and transport assignments.

Experience dynamic steering, the biggest invention since power steering. Read about the new rear air suspension for the gravel pit, the new integrated system for services and infotainment, and the brand new I-Shift with crawler gears. Taking productivity and driving comfort to new heights. Welcome to the future.

**OVERVIEW**

# A closer look at the Volvo FH

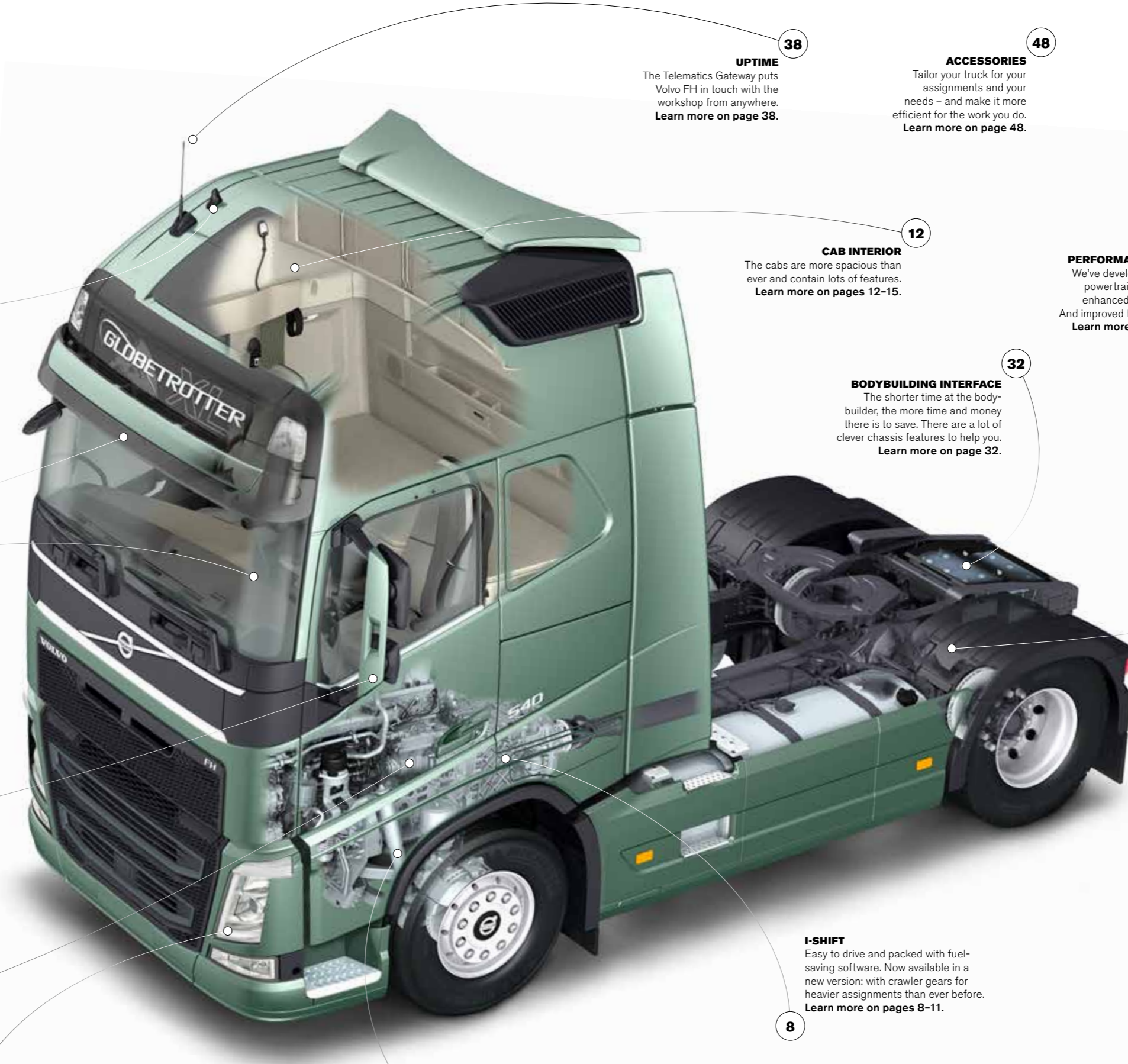

**VIEW SOME OF THE SPECS ON PAGES 46-47**

**20**  
**I-SEE\***  
A cruise control that plans ahead – our latest addition to the intelligent I-Shift software is revolutionary. And it saves up to 5% fuel.  
**Learn more on page 20.**

**44**  
**DRIVER SUPPORT SYSTEMS**  
The forefront of safety is Volvo's home ground. Our advanced driver support systems efficiently helps the driver avoid accidents. **Learn more on page 44.**

**18**  
**DRIVER INTERFACE**  
The instrument cluster and the new touch display offers an industry leading drive interface. **Learn more on page 18.**

**34**  
**REAR-VIEW MIRRORS**  
The aerodynamic mirrors, rear-view cameras and the upright A-pillars provide visibility you've never seen before. **Learn more on page 34.**

**22**  
**VOLVO DIESEL ENGINES**  
Fuel-efficient and torque-strong 13-litre engines, up to 540 hp. Pick the perfect choice for your assignments. **Learn more on page 22.**

**30**  
**LOW SLEEPER CAB**  
The extra low cab is ideal for construction or mining assignments. **Learn more on page 30.**

**40**  
**HEADLIGHTS**  
Dynamic headlights, static cornering lights, improved main beams and more. **Learn more on page 40.**

**42**  
**LOAD HANDLING**  
ECS4 is the latest version of Volvo's electrical suspension system. The biggest news? A wireless remote. **Learn more on page 42.**

**16**  
**HANDLING**  
We've designed every part of the truck to contribute to stable and precise handling. **Learn more on page 16.**

**8**  
**I-SHIFT**  
Easy to drive and packed with fuel-saving software. Now available in a new version: with crawler gears for heavier assignments than ever before. **Learn more on pages 8-11.**

**6**  
**VOLVO DYNAMIC STEERING**  
The biggest invention since power steering lets you enjoy effortless manoeuvring with extreme precision. **Learn more on page 6.**

**28**  
**TANDEM AXLE LIFT**  
Only use the extra drive axle on your tandem drive when you need it. Tandem Axle Lift reduces your fuel consumption, tightens your turning radius and improves your traction. **Learn more on page 28.**

**38**

**UPTIME**  
The Telematics Gateway puts Volvo FH in touch with the workshop from anywhere. **Learn more on page 38.**

**48**

**ACCESSORIES**  
Tailor your truck for your assignments and your needs – and make it more efficient for the work you do. **Learn more on page 48.**

**12**

**CAB INTERIOR**  
The cabs are more spacious than ever and contain lots of features. **Learn more on pages 12-15.**

**32**

**BODYBUILDING INTERFACE**  
The shorter time at the body-builder, the more time and money there is to save. There are a lot of clever chassis features to help you. **Learn more on page 32.**

**24**



**PERFORMANCE & FUEL**  
We've developed a unique powertrain that delivers enhanced performance. And improved fuel efficiency. **Learn more on page 24.**

**26**

**REAR AIR SUSPENSION**  
Experience the air-suspended rear-wheel installation. One could say it's an earth-quaking development and now you can get an even lighter installation for more payload. **Learn more on page 26.**

## VOLVO DYNAMIC STEERING

# Responding to your slightest command.

## And nothing else.

What has been called the biggest thing since power steering is now available in a series-production truck, both with single and dual front axles. Volvo Dynamic Steering is based on a patented concept, and will completely change the way you drive. Try it, and you'll never want to go back to a regular truck. Even your car will pale in comparison.



### How it works.

Volvo Dynamic Steering consists of an electric motor, connected to the steering gear. By receiving input from several sensors, the ECU (Electrical Control Unit) can determine where the truck is going as well as what the driver's intentions are.

The motor is controlled 2000 times every second, using a principle called "torque overlay", to correct unintentional steering movements and to provide extra torque when needed. Altogether creating a perfect and consistent steering feel, regardless of load and tyres.



**EFFORTLESS**  
Volvo Dynamic Steering decreases the steering effort by up to 85%.



**At high speeds:**  
**Let nothing set you off course.**  
Driving straight isn't as easy as one would think. In fact, you often have to compensate for kicks from road ruts, pot holes and road markings. Or correct your course after braking on a mixed-friction surface. Yes, sometimes even side winds can disturb your ride.

Volvo Dynamic Steering changes this completely. Just loosen your grip on the wheel, concentrate on the traffic and be sure the truck won't change direction until you want it to.



**At low speeds:**  
**Steer with one finger and save your back.**

This is where Volvo Dynamic Steering really will change your day. And your future. Because you no longer need to strain your muscles to manoeuvre the truck at low speeds. Volvo Dynamic Steering provides you with all the steering force you need. You can literally steer the truck with one finger. This not only gives you complete control of the vehicle but also practically eliminates the strain on your neck and shoulders.



**When reversing:**  
**Perfect control without strain.**

Reversing with a fully laden truck is one of the most challenging and trying aspects of the job. Especially where you need to focus every bit of your attention on the surroundings. Not so with Volvo Dynamic Steering. You now reverse with perfect precision – almost without effort. And as soon as you let go of the wheel, it automatically returns to neutral, reducing the strain even further.

Furthermore, if you need to reverse long distances, here's something unique. The course stability is so great that you can reverse a truck and trailer more than a hundred metres without drifting off course.

# Forget the gearbox. Just drive.

## How it works.

It may seem strange. Beneath the surface of I-Shift, the archetype of modern transmissions, hides an old-school unsynchronised manual gearbox. (Hence the compact design and low internal losses.) But of course there's much more to I-Shift than that. The secret lies in the intelligent electronic control unit. It's responsible for controlling the pneumatic system that handles the clutch and shifts. By constantly receiving information about vehicle speed, acceleration, weight, road grade, torque demand and more, it can carry out every shift with extreme precision. It also communicates closely with the engine, which in turn adjusts revs and engine brake effect for fast and comfortable shifting.



## Eases your mind. And lets your left foot rest.

Driving I-Shift is a real pleasure. Without the clutch pedal, you can safely sit back and concentrate on the other two. I-Shift uses its built-in intelligence to quickly and automatically choose the right gear at all times. And the software provides shifting skills that are impossible for even the best of drivers to match. Still, if you want to get more involved, you can. The buttons on the shift selector allows you to step in and shift gear manually.



## An unexpected option. I-Shift without gearstick.

If you're used to driving with I-Shift, you've probably noticed that you don't actually use the shift selector that much. That's why the Volvo FH offers you the option of getting rid of it altogether and have it replaced with four switches on the dashboard (still within easy reach, of course). Freeing that precious space makes it a little bit easier to move around in the cab.



## Let I-Shift save you fuel. The money will roll right in.

I-Shift is designed to save fuel. First of all, the internal energy losses are low – actually lower than on manual gearboxes. But it's the electronics that really make the difference. When driving in Economy mode, every gearchange is timed precisely, to let the engine work at its most efficient rpm range. And then there's I-Roll. It's a unique feature used when driving downhill, automatically disengaging the engine to make use of the truck's momentum instead of fuel. The result? Up to 2% lower fuel consumption.

Not enough for you? Add I-See\* to save more. Learn more on [page 20](#).

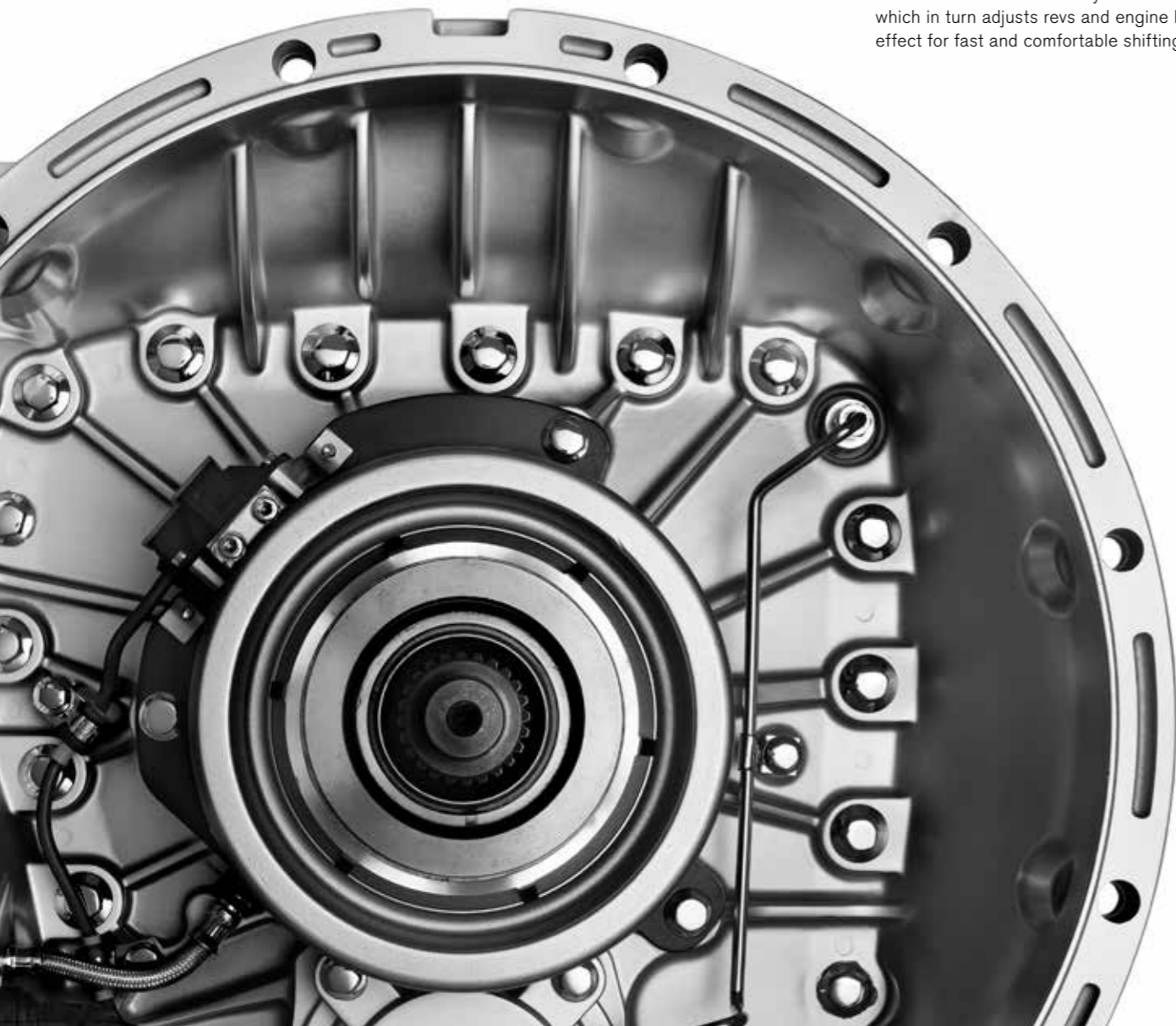

## How would you like your I-Shift?

The software makes it possible to tailor I-Shift to your driving conditions. Choose from four add-on packages: Long Haul (with or without I-See\*) for efficient highway driving, Distribution with smart functions for close-quarter manoeuvring, Construction that handles tougher road conditions, and Heavy Duty Transport (with or without I-See\*), optimising I-Shift for gross combination weights above 85 tonnes. 🚚



## When things get really tough the I-Shift for heavy duty makes it easier.

If you're into heavy assignments in very hilly terrain you can count yourself lucky. Now there's an I-Shift for you, too, perfectly suited to your specific needs, offering you all the comfort and fuel economy of the I-Shift gearbox.

We've developed a clutch with a larger diameter on the damper mechanism, and new clutch and gear control software for high torque. The result is an I-Shift gearbox perfectly adapted for timber and construction assignments as well as other heavy applications. And if this shouldn't be enough, you should check out the I-Shift with crawler gears. Learn more on [page 10](#).

# The fastest way to productivity? Slow down.

I-Shift just got even more versatile and easy to drive. The automated gearbox is now available with the choice of one or two crawler gears, plus the additional option of extra reverse gears.



**Start wherever you want.**  
If you transport heavy loads, you know that starting from a standstill can sometimes be difficult, especially in hilly terrain or poor road conditions. Ultimately, you may have to unload the cargo or even request towing, which has devastating effects on your uptime and productivity. Equip your FH with crawler gears and this will be a worry of the past. Your startability is dramatically improved, and the strain on the clutch is reduced by up to 75 percent, saving you from unnecessary repairs.



**Crawl slow, run lean.**  
Can crawler gears really help boost your fuel economy? Sure. Because previously, you often had to be willing to sacrifice fuel economy for startability. But thanks to the crawler gears, we can now specify your truck with a faster rear axle ratio, allowing you to stay on cruising speed at much lower revs when you're driving on decent roads. This lowers your fuel consumption by up to a couple of percent.



**Say yes to extreme conditions.**  
Crawler gears adds to the versatility of the truck, letting you use the same truck for a host of different driving conditions and assignments. Drive both on-road and off-road? Need to transport extreme loads up to 325 tonnes? Work at high altitudes? Special low-speed applications? No problem.



**Perfect control in any direction.**  
Low-speed manoeuvring is one of the most challenging aspects of the job. Thanks to a transmission ratio of up to 32:1 (and up to 37:1 in reverse), the crawler gears let you drive slower than ever – half the speed compared to a regular I-Shift. You always have total control, making it easy to manoeuvre with high precision even in poor conditions.

**SLIM GEARS**  
The crawler gear module only adds 120 mm to the length and 48 kg to the weight of I-Shift.

# Globetrotter reinvented.

THE SKY IS THE LIMIT

BACK-SAVING STEERING WHEEL ADJUSTMENT WITH NECK-TILT

PLENTY OF ROOM FOR STUFF

BUILT-IN PARKING COOLER

MODERN AND ERGONOMIC DASHBOARD

PLENTY OF SPACE BETWEEN WHEEL AND BELLY

WIDE AND COMFORTABLE BED FOR SLEEP OR REST

MORE FEATURES OVERLEAF

## CAB INTERIOR

# Packed with features. And space.



### Everything at your fingertips.

Easy-to-use navigation and fleet management. Improved communication and increased safety. Enhanced quality audio entertainment. Volvo's integrated system for services and infotainment brings together everything you need on the 7-inch touch screen. Learn more on [page 18](#).

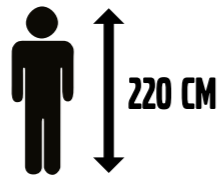

### Full standing height.

Unless you're a professional basketball player, here's plenty of headroom. 220 cm in the largest cab, Globetrotter XL. It's not only practical, it also gives a spacious feel.



### Modern and ergonomic dashboard.

The gently curved dash not only looks appealing. It's designed for an ergonomic and comfortable driving position with all buttons, instruments and storages within easy reach.



### Sound system.

The sound system includes everything you need to enhance your in-cab experience. Access to streaming media services such as Spotify, Deezer and TuneIn. DAB/DAB+ (Digital Audio Broadcasting) as option.



### Plenty of room for stuff.

You can have everything in place. The spacious front, under-bunk, rear and exterior storages can be tailored to your needs, and are accompanied by plenty of convenient compartments for smaller items.



### Advanced interior lighting.

13 energy-efficient and powerful light sources make for fantastic in-cab lighting. All are easily controlled in three preset steps or with the dimmer. When driving in the dark – switch to the red lights to preserve your night vision.



### ECC with air-quality sensors.

Electronic climate control with top-notch air vents and a multitude of sensors and filters, processing the air before it fills your lungs. The result is unprecedented air quality, improved defrosting and a draft-free environment.



### Wide and comfortable bed for sleep or rest.

No need to sleep tight. The lower bunk is wide and offers first class comfort. There's even a really wide retractable bed. And the head part can be inclined up to 55°.



### Stay in bed.

The advanced sleeper panel lets you control the interior lights, alarm clock, parking heater, parking cooler, audio system, windows, roof hatch and locks. All without leaving the bunk.

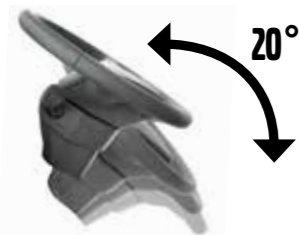

### Back-saving steering wheel adjustment with neck-tilt.

The fully adjustable steering wheel with a 20° neck-tilt function makes for comfortable driving. Folds away easily when you enter or exit the cab. Conveniently controlled by a foot pedal.

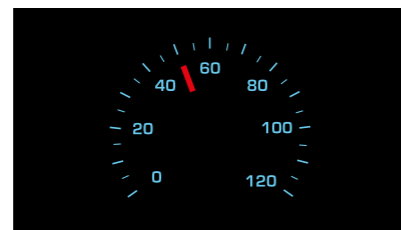

### Night mode.

A standard safety feature that allows you to turn off all backlights in the instrument cluster, except for the speedometer. You won't be distracted by irrelevant lights. This makes it safer to drive at night – or to connect the trailer when visibility is poor. However, if a warning alert occurs, it will show up on the panel.



### Built-in parking cooler.

Superior cooling capacity, without compromising in-cab space or aerodynamics. I-ParkCool is the integrated parking cooler that lets you sleep well at night, and save fuel during the day.



### Clean water anywhere.

If you want fresh water, you don't have to go far. The exterior compartment holds a 7-litre tank equipped with a tap.



### The sky is the limit.\*

Adding to the spacious feeling, the tinted glass sky window is the finest emergency exit you'll ever see. It has sun blinds and mosquito net, and can be fitted with an electrically controlled hatch.



### Electric parking brake.

The electrically controlled parking brake is handled with an easy-access dashboard switch. Automatically engages at key-off, and – with a little help from EBS – automatically releases when taking off.



### All at your thumb tips.

Buttons for cruise control, audio, phone and what's in the information displays, allow you to keep a tight grip on the wheel.



### Electronic remote key.

It's more than a key. Lock or unlock from a distance. Turn on the lights to approach the cab safely. And if you're feeling threatened, just push the panic button to blast the horn.



### Plenty of space between wheel and belly.

Don't get stuck behind the wheel. The seat adjustment range is of world class – a whole 24 cm from front to back. That means drivers of all sizes sits comfortably.



### Prepared for a 19" TV.

Volvo FH can be factory-prepared for mounting a TV set – complete with brackets, antenna and outlets for power and TV signal, as well as an aux input, connecting the TV to the audio system.



### A comfortable ride.

All the different options of cab suspension. The improved steering-gear position. The well designed front-end geometry. The smooth engine mounting. And more. We've taken many steps to create world-class comfort and driving pleasure.



### Room for alcoholock.

Alcohol doesn't belong in traffic. That's why the alcoholock does. Factory fit it to your Volvo FH, and send a clear message to your customers how seriously you take road safety.



## HANDLING

# Handles like no other truck.

Volvo FH has handling characteristics above the ordinary. We've virtually designed every part of the truck to contribute to the stable feel and precise steering. You really have to experience the result for yourself. But if you want to know why it performs so well, here's the quick-list:



### **The rear suspension stabiliser bar.**

New Volvo-patented design with stabilisers in front of the axle eliminates rear-chassis torsion. This provides a very stable course and therefore a comfortable, safe and rapid ride. The re-designed stable bar also makes it possible to specify the truck with short rear overhang, great for construction applications.

### **The engine suspension.**

Improved front mounting prevents vibrations from spreading through the truck, to provide an even more comfortable ride.

### **The front suspension.**

Enhanced geometry on leaf suspensions. Improved design on all air suspensions. Here is one of the major reasons why the truck behaves very stable and safe on the road. Take a drive yourself and feel the comfort.

### **The rear cab suspension.**

The cab must be softly sprung in order to be comfortable to ride in. But it must not lurch because this would result in gravity shifting of the vehicle, which would affect the handling characteristics adversely. We solved it with a sophisticated suspension. Vertical springs with increased spread promote stability and driving comfort.

### **Volvo Dynamic Steering**

Fast and precise torque overlay by electronic motor and unique, patented concept. Resulting in improved directional stability, low shunting steering forces and suppression of road disturbances.



## DRIVER INTERFACE

# A world of infotainment at your fingertips.

Easy navigation and improved communication. More efficient fleet management. Volvo Trucks' integrated system for services and infotainment brings it all together on an integrated touch screen – for a safer more comfortable driving experience.

It's easy-to-use and it can be operated directly on the screen, via voice command, and by steering wheel buttons. All the information is where you need it. In one place. Stay connected.



### Information is central.

A quick glance at the centre of the speedometer is enough to get key information about gear, I-Shift mode, (adaptive) cruise control, auxiliary brakes and tachometer.

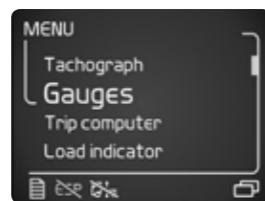

### Driver Information Display.

Convenient 4-inch display showing a lot of additional information. Choose what you want to see, using the steering wheel buttons. The customised view allows you to select up to three favourites such as different gauges, driver alert support or load indicator. If an error should occur, the message tells you in clear text what's wrong. No risk of misunderstanding. Available as monochrome or colour display.



### Secondary Information Display.

It gives you access to the integrated system for services and infotainment. Navigation, fleet management, communication, increased safety and quality audio entertainment – it's all there on a 7-inch touch screen. 📱

### BUILT-IN GPS NAVIGATOR

The Volvo FH has a fully integrated navigator. Knowing the truck's specification, it can use map data to help you choose a route that suits your axle load and vehicle height. It also integrates nicely with Dynafleet OnBoard, so you can receive exact GPS destinations from the office. 📱

### DYNAFLEET ONBOARD

No separate display needed. All information from Volvo's transport management system is integrated in the SID-High. 📱

### SOUND SYSTEM

The sound system includes everything you need to enhance your in-cab experience. Access to streaming media services such as Spotify, Deezer and Tuneln. DAB/DAB+ as option. You can connect via USB, AUX or wireless via your smart phone. 📱

### PHONE

Two phones can be connected via Bluetooth at the same time so you can browse your phone book, talk into the built-in microphone and listen through the speakers.



I-SEE\*

# Now every road is worth remembering.



## Lower fuel consumption by 5%. Just activate the cruise control.

Combine I-Shift and the GPS with an intelligent cruise control, and you get I-See. It's a unique system that learns the topography of the road and stores it in a central database. When you're driving, it automatically uses its knowledge to save fuel – up to 5% during a driving cycle (when I-Cruise is engaged the whole time).

## Wherever you are, you can get help from the cloud.

I-See doesn't rely on maps. Since reality tends to be more accurate, it memorises the actual slopes instead. And you don't have to have travelled the route before to save fuel. I-See stores all hills in a database free for all other trucks to use. As long as someone has travelled the route before, I-See can download the data and start saving fuel immediately.

### BEFORE THE UPHILLS: TAKING OFF.

When I-See knows an uphill is coming, it lets the speed increase, approaching the upper speed limit, to gain momentum. The truck can stay longer in a higher gear.

### ON THE UPHILLS: KEEPING FROM DOWNSHIFTING.

When climbing, I-See uses its stored knowledge to avoid unnecessary downshifts towards the top. You approach the crest smoothly without wasting fuel in a lower gear.

### ON THE CRESTS: STAYING CALM.

When approaching a downhill, I-See keeps the truck from accelerating unnecessarily.

### BEFORE THE DOWNHILL: ROLLING ON.

Just before the slope, the driveline temporarily disengages, allowing the truck to roll. This saves energy, and minimises the need for braking.

### ON THE DOWNHILLS: BRAKING IN TIME.

I-See knows when the slope ends. Thus, when gaining speed downhill, it can apply the engine brake gently in time – instead of abruptly at the end – to prepare for the upcoming topography.

### IN THE HOLLOWES: SOME EXTRA SCHWUNG.

When a downhill is followed by an immediate uphill, I-See really comes to its right. It lets the truck roll, gaining speed and momentum to climb uphill with less effort.

### I-CRUISE

One part of I-See is called I-Cruise. It's the intelligent cruise control that adjusts the speed for minimum fuel consumption. You can order it separately, and save up to 2% fuel.

# This is where fuel efficiency starts.

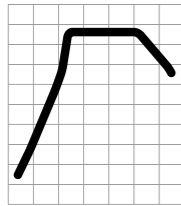

### The Volvo torque curve. You'll feel it in the pedal.

Excellent torque at low revs. An extremely wide max torque range. Peak torque meets peak power. Volvo's leadership in diesel-engine technology is clearly visible once you start comparing engine curves. You'll experience fast acceleration, excellent pulling power, comfortable low-speed handling and, not least, a fuel-efficient and pleasurable ride at cruising speed.



### Pick the best power rating.

The engine range for Volvo FH comprises four different power ratings that makes it easy to pick the one that suits your transport assignment.



### Fuel-efficiency built-in.

We could go on listing what makes Volvo engines hard to beat at fuel economy but let's focus on the news that take our engines steps ahead. The new common rail injection system on all D13 engines. Increased compression rate on the 420 and 460 models – and a new optimised turbo on the 500 and 540 levels all add to the improved efficiency. Your bottom line will reap the benefits. So will the environment.



### VEB+. Up to 510 hp of braking power.

Minimise wear on the brake pedal. Volvo's patented engine brake absorbs up to an impressive 375 kW (510 hp) on the D13, thanks to the unique camshaft design with four rocker arms. Integrated with I-Shift and the cruise control, it lets you maintain a high average speed without compromising safety or fuel economy.

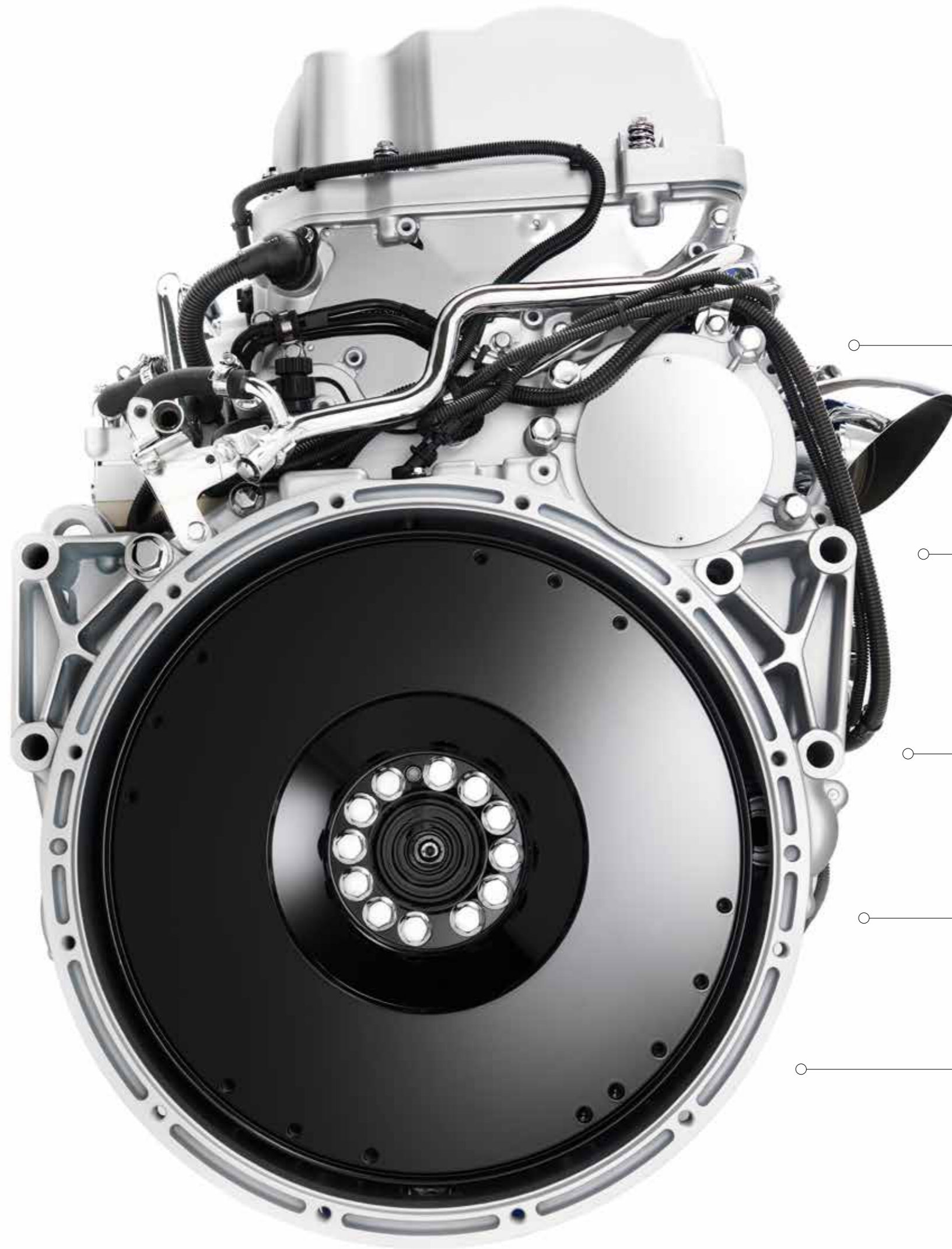

### INLINE SIX

6 cylinders. 7 bearings to distribute the forces. Reliability never goes out of style.

### EMS-CONTROLLED UNIT INJECTORS

Up to 2400 bar of injection pressure with perfect timing, thanks to the Engine Management System (EMS).

### CLOSED CRANKCASE VENTILATION

Recycles the crankcase gases, for improved air quality around the vehicle.

### REAR TIMING MECHANISM

A compact and weight-saving design, powering the air compressor along with the power steering, oil, and fuel feed pumps.

### HYDRAULIC PUMPS WITH CLUTCHES

The range of engine-mounted hydraulic pumps includes two declutchable ones.

# Maintain speed. Save fuel.

Maintaining speed while saving fuel. It's a tough balancing act. We understand your daily challenges of delivering on time while controlling your costs. That's why we've developed a unique powertrain that delivers enhanced performance. Improving fuel efficiency and reducing your environmental impact. Here are the top features that will support you.



### The right ratio.

What do we mean by the correct ratio? Well, it's all about rear axles. These are the last link in an efficient chain, which delivers power from the engine to the truck's wheels. By equipping our rear axle with the right ratio for long haul, it works in perfect harmony with our D13 engine and I-Shift automated gearbox. The result? Low revs. A comfortable drive. And great fuel efficiency.



### Better startability with crawler gears.

I-Shift with crawler gears. Developed for heavy transport and construction. A faster rear axle ratio allows you to maintain cruising speed at much lower revs. And lower revs save fuel. Starting from standstill with heavy loads just got much easier. Even in extreme conditions with up to 325 tonnes on-board.



### Energy saving tyres.

Our tyres help bring out the best in your truck. For example, 315/70 R22.5 tyres are specifically designed for long haul transport. Fuel savers to suit your assignment. The right pressure in your tyres, together with correctly aligned wheels and axles, can go a long way to helping you save fuel and money in the long run.



### Shut down and save fuel.

Small changes can make a big difference. Engine driven components consume fuel when in use. Air compressors. Steering servo pump. And even the engine itself. Shutting them off when they are not in use saves fuel. And money.



### Every road remembered.\*

Which route will use up least fuel? I-See memorises and stores all hills in a central database. Free for other trucks to use. This information allows the truck to automatically react to gradients in order to avoid unnecessary gear changes. No maps or GPS required. Combine I-Cruise with I-See and you have a faithful fuel-saving partner. 📦



### Intelligent cruise control.\*

I-Cruise helps keep speed steady. It adjusts your speed in order to keep fuel consumption down. This not only helps towards your productivity by maintaining a high average speed. It also contributes to a safer, more comfortable drive. 📦



### A smooth body.

Airflow packages minimise wind resistance and keeps fuel consumption down. With the help of wind tunnel tests, we have finetuned the wind deflectors. The result? Significantly lower fuel consumption. 📦



### Tailor your I-Shift.

Make I-Shift work for your business. There is a range of software packages to suit your driving conditions. Long Haul optimises cruising speeds. This makes for efficient highway driving. 📦

## REAR AIR SUSPENSION

# There's a right solution for every job.

Compared to traditional leaf suspension, air suspension offers many benefits. It provides a smoother ride, regardless of the road conditions – saving the truck, the cargo and, most importantly, the driver from additional wear. Different jobs require different solutions and since the Volvo FH can cover everything from fast and efficient long haul transports to tough construction work, we have solutions that optimise them all.

Our rear air suspension that is especially developed for construction trucks, offers high ground clearance (at least 300 mm) and is tough enough to handle rough terrain. And for long haul transports we now introduce an even lighter rear air suspension alternative as well as a lighter more compact pusher axle.



### Weight saving rear axle installation for long haul.\*

If weight is critical to your transport assignments, the new optimised air suspended rear axle installation, GRAS-G4, reduces the vehicle weight with 90 kg while still offering an 11.7 tonne axle load capacity. It comes in a wide range of axle ratios and is an excellent choice for 4x2 tractors in long haul transports up to 44 tonnes combination weight.

### Light weight pusher axle.\*

A weight optimised 6x2 pusher installation reduces the truck's kerb weight with up to 500 kg, meaning a potential for increased payload. The new installation is more compact and makes room for bigger fuel tanks and other equipment on the chassis.

### STABILISERS IN BOGIE CENTRE

The position of the stabiliser bar results in less torsion forces on the chassis and better roll and tipping stability. It also contributes to the high ground clearance.

### AIR BELLOWS MOUNTED ABOVE THE AXLE

The air bellows are well protected and their positions contribute to the high ground clearance. As do all other components.

### PROTECTED BRAKES

Don't worry. No parts of the braking system stick out beneath the rear axle. That's why you can be sure that the truck can handle all obstacles.

### AIR SUSPENSION

Air suspension provides outstanding driving comfort and makes it possible to vary the ground clearance. No parts of the suspension lay outside the rear tire envelope. This makes it easier to adapt the chassis for applications such as asphalt layers or tippers.

### BETTER TRACTION AND HIGHER AVERAGE SPEED

Optimised rear-axle pressure on every axle means better traction, thanks to the air suspension. The driver can adjust axle load distribution for better traction if needed. Air suspension gives less vibration into the truck and you will get an improved driving comfort, especially when unloaded. This will also contribute to a higher average speed.

### HIGH BOGIE LOAD

Tandem: 26 tonnes.  
Tridem: 36 tonnes.

### HIGH GROUND CLEARANCE

300 mm under the stabilisers.  
335 mm under the differential.



## TANDEM AXLE LIFT

# Lower fuel consumption and turning radius?

## Just raise the drive axle.

Tandem Axle Lift is a unique feature, allowing your 6x4 or 8x4 to combine the traction and load capacity of four-wheel-drive with the driveability and efficiency of two-wheel-drive – all in one vehicle.



### Up to 4% lower fuel consumption when unladen.

Because of the added friction and rolling resistance, drive axles usually consume quite a lot of fuel – all of the time. Not so with Tandem Axle Lift. By disengaging and raising the drive axle when it isn't needed, you can reduce your fuel consumption by as much as up to 4% when unladen. That adds up to a lot of money in the long run.

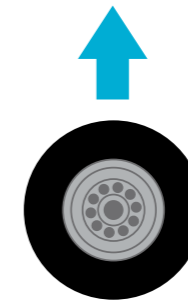

### Get a grip.

As long as the axle load limits allow, the axle can be raised to shift all the weight to one drive axle, for better grip and traction. It can even be performed while driving at low speeds.



### Enjoy better turning radius.

Tandem Axle Lift can effectively convert a 6x4 to a 4x2, or an 8x4 to a 6x2. Just like when raising a dead axle, this significantly improves the manoeuvrability of the truck by shortening the turning radius. In fact, a 6x4 with a wheelbase of 4.6 metres, for example, can reduce its turning radius by over a metre.

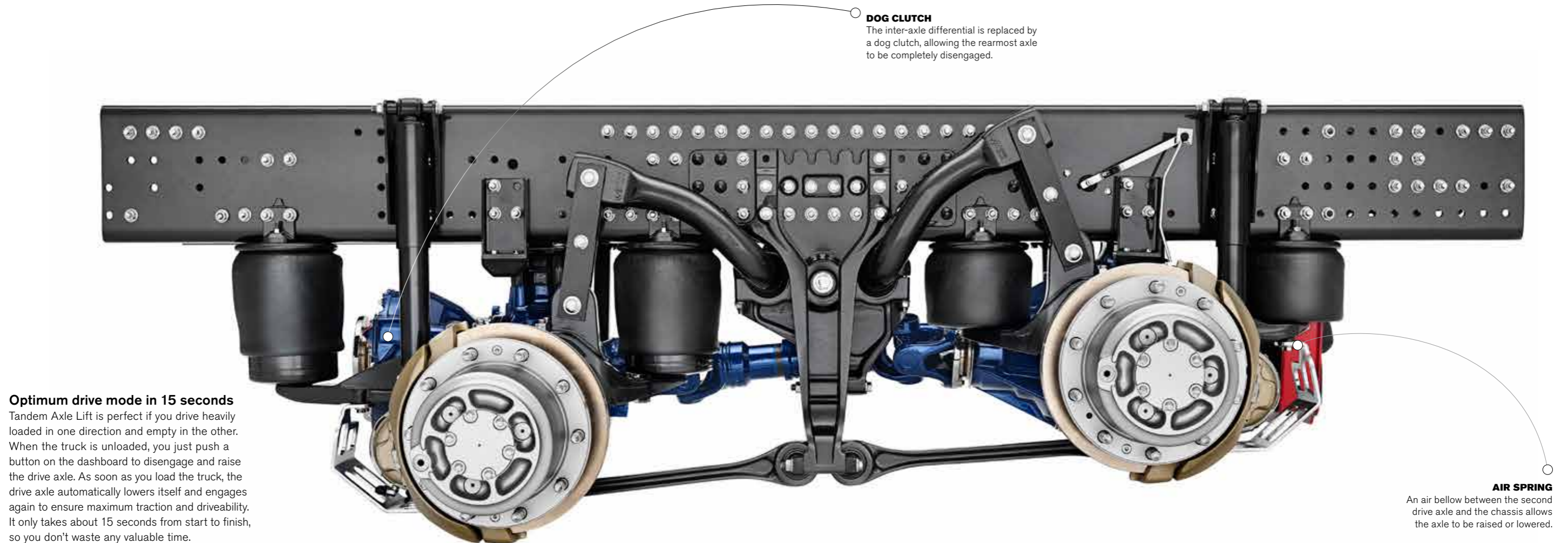

### DOG CLUTCH

The inter-axle differential is replaced by a dog clutch, allowing the rearmost axle to be completely disengaged.

### Optimum drive mode in 15 seconds

Tandem Axle Lift is perfect if you drive heavily loaded in one direction and empty in the other. When the truck is unloaded, you just push a button on the dashboard to disengage and raise the drive axle. As soon as you load the truck, the drive axle automatically lowers itself and engages again to ensure maximum traction and driveability. It only takes about 15 seconds from start to finish, so you don't waste any valuable time.

### AIR SPRING

An air bellow between the second drive axle and the chassis allows the axle to be raised or lowered.

## LOW SLEEPER CAB

# The lower cab is the main highlight.

When the ceiling is low on your routes. When the crane is resting on the roof. When the road and the load require a powerful transmission. That's when you appreciate a Volvo FH with an extra low cab.



### A clean cab roof.

If you want to take advantage of the low cab height, then you don't want anything sticking up from the roof. Fortunately, the antennas on the Volvo FH can all be moved out of the way. The FM and GSM/GPS antennas can be moved to the right-hand cab side and the CB and toll collect antennas to the left-hand side.



### Low ceiling, but still free space above the roof.

If you are into mining transports then you probably know that the corridors normally have a clear height of 3.4 meters. That means that with the low cab of just over three metres you go free. For trucks used in mining, you can choose the low cab with the additional protective roof. It does not add more than a minimal 15 mm in height.



### Perfect for mining applications.

Do you operate in mines or other environments where the headroom is limited? The low sleeper cab is developed with this in mind. We've even lowered the cab suspension by 20 mm, put 22.5" tyres and a low front axle on it to make a perfect solution when you need to go low.



### Driving comfort. A matter of height.

The air suspension system ECS4 lets you choose from three customisable driving heights, to optimise ground clearance or aerodynamics, improving ride comfort even further.

The total height of a Low Sleeper Cab truck can be specified to less than 3.2 metres high.

**< 3200 MM**





# Prepared to fit your body.

Bodybuilders tend to have a favourite truck and that is Volvo. That's because we've gone great lengths to make things easy for them by preparing the chassis for the superstructure already at the factory. They can avoid unnecessary and costly reconstruction work and that means a shorter stay at the bodybuilder's. Here are some of the features that will make a difference.



**When low weight is essential.**

Low weight means more payload and lower fuel consumption. That's why we continue to optimise every part of the truck to make it lighter. Recent achievements are a 5th wheel ramp saving up to 10 kg and a lighter frame for tridem rigid models with considerable weight reduction. Not to mention the weight reduced front axle hub that makes it possible to increase the front axle load from 7.1 to 8.0 tonnes.



**Volvo Bodybuilder Instructions.**

As soon as you order your Volvo FH, exact drawings of your very truck are available in the intuitive VBI online portal. The bodybuilder can start working while we build the truck, which dramatically shortens lead-times.



**Power take-offs for every need.**

There's a vast array of PTOs: Engine mounted as well as gearbox mounted, including both clutch-independent and clutch-dependent power take-offs. There is also a wide range of hydraulic pumps even with clutch to save fuel.



**The frame is straight.**

Unlike most other trucks, a Volvo features a frame that is completely straight and parallel behind the cab. This makes the bodybuilder's job a whole lot easier.



**Staying out of the bodybuilder's way.**

We never allow our engineers to place anything above the top of the frame. This area belongs entirely to the bodybuilder – adding a lot of flexibility.



**A dedicated row of holes.**

The frame comes with an upper row of holes that is designated for the superstructure. Since we don't use any rivets here, the bodybuilder can easily attach the equipment.

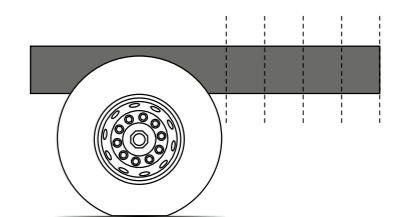

**Choose your exact rear overhang.**

The rear frame can be factory cut exactly as you need it – in 50 mm increments – to perfectly match your superstructure. Regardless of whether you are in need of an extremely short rear overhang or a longer one.

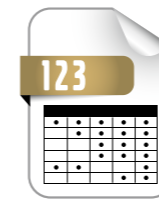

**Loads of specification options.**

The more possible combinations, the easier a truck is to tailor. That's why the Volvo FH has more options than ever before when it comes to axle configurations, chassis heights and wheelbases.

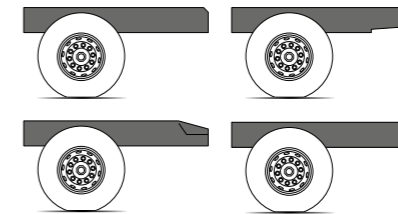

**4 different rear end cuts.**

We can deliver your FH from factory with four different rear frame-end cuts: upper (for tippers, hook-lifts and refuse trucks), lower (for centre-axle trailers), bent (for tractors) or straight (for rigid).



**Rear underrun position.**

To widen the rear end options even further, the rear underrun protection can be placed in several different positions.



**Two different frame heights.**

Choose between a 266 mm and a 300 mm frame depending on the demands of the superstructure.



**Body Builder Module.**

Makes it easy for the bodybuilder to tap into the truck's electrical system to tailor functions. You can access them conveniently on the flexible dashboard switches and in the Work Remote. 📱



**Perfect for swap bodies.**

Not all truck bodies are permanent. The 295 mm stroke of the rear air suspension in combination with the extra low chassis is the perfect solution if you transport temporary ones.



**Attachment brackets.**

Volvo FH can be factory prepared with body attachment brackets, mounted on the frame. Now available not only in the wheel-base area, but also on the rear overhang.



**Prepared for a crane.**

A low chassis and high axle loads. That is what's on every crane builders wishlist. Volvo FH comes with both. What's more, we can create a free frame space near the cab, and even deliver your truck with factory-mounted crane plates.

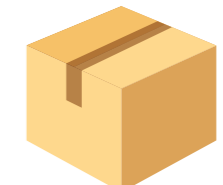

**Rigid chassis package.**

Options like side underrun protection, bodybuilder attachments, mudguards and LED tail lights are available in a convenient package – easy to order and with high quality.

📱 Also available as an accessory.

## REAR-VIEW MIRRORS

# Mirrors that keep out of your way.

### Ultra-slim housing. For safety.

The side mirrors' slim design adds to the cab's distinctive profile. They not only help you see better backwards, they also reveal more when you look ahead. As a bonus, the design also helps improve aerodynamics and is less sensitive to soiling.



### Electrically controlled and heated.

No need to scrape frost or moisture off the mirrors. The heated mirrors take care of that for you. And since all rear-view mirrors are electrically controlled, you can adjust them precisely without leaving the cab. Just as convenient as it should be.



### Exterior vision cameras. When there's more to see.

There are certain angles no mirror in the world can reach. Fortunately, Volvo FH is factory-prepared for fitting up to four exterior cameras, wherever you need them. Connected to the integrated secondary information display (SID-High), they provide a handy way to take a glance backwards, for example when reversing or checking the load. 📺



### Lane Changing Support. Goodbye blind spot.

Just beside the rear-view mirrors on the passenger side is a small but significant icon. When lit up, it indicates that Lane Changing Support has spotted something in the blind spot area, and you should refrain from changing lane until it's clear. Indeed a life-saving safety feature. Read more about all our driver support systems on [www.volvotrucks.com](http://www.volvotrucks.com)

### The gap that improves safety.

Upright A-pillars with a slim cross-section and slim mirror design – this does wonders for the visibility from inside the Volvo FH cabs. This is invaluable, not least in city traffic, allowing you to spot other road users, such as pedestrians and cyclists.



**THE FUEL DEAL**

# Every drop counts.

Cutting fuel costs and emissions should be easy. That's why we've bundled our most efficient fuel-saving options into two packages. One of them adds features to the truck itself. The other is a collection of several useful services. If you sign up for both, you can count on reducing your fuel consumption by up to a full 11%. You can of course also get the two separately, or just pick the features you like.



**Dynafleet app.**

Want to see how fuel-efficient you were on your last shift? All you need is Dynafleet and a smartphone or a tablet. Just download the app, and you've got yourself a great way to improve your skills. Or maybe challenge your colleagues.

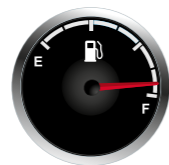

**More room for fuel.**

Speaking of fuel. The flexible chassis layout of Volvo FH allows you to optimise your truck for the fuel capacity you need. With a vast range of tanks, where the largest single tank is 900 litres and AdBlue tank volumes up to 100 litres, there's a good chance you can tailor your truck to carry the maximum amount of fuel allowed.

**DYNAFLEET FUEL & ENVIRONMENT**  
Volvo's fleet management system lets you monitor fuel consumption in real time from the office through an intuitive web interface. Analyse trends and find out where there's room for improvement, guided by built-in reports on driver behaviour, fuel and environmental impact.

**DRIVER TRAINING EFFICIENT DRIVING**  
Skilled drivers have an enormous impact on fuel-efficiency. Efficient Driving is the course where we focus on how to drive smartly and save fuel.



**24 V 150 A ALTERNATOR. MORE POWER FOR LESS FUEL.**  
A very energy-efficient alternator, needing less fuel to charge the batteries. Especially valuable if you consume a lot of power, for example when you're spending the nights in the cab.

**I-SEE.\* THE FARSIGHTED CO-PILOT.**  
I-See memorises all travelled roads in a data base. I-See can download the data, making it possible to control gearshifts and speed to make maximum use of the truck's momentum, leading to substantial fuel-savings. Read more about I-See on [page 20](#).



**ENGINE IDLE SHUTDOWN. SAVE FUEL WHILE STANDING STILL.**  
A smart feature that lets you save fuel by automatically turning the engine off after two and a half minutes of idling.

**CLUTCHABLE AIR COMPRESSOR. NO UNNECESSARY PRESSURE.**  
The air compressor is automatically declutched when not needed, leading to lower fuel consumption.

\*Also available as an accessory. \*I-See is only available on Euro 5 and Euro 6 markets.

# Stay on the road by staying online.



### **Volvo Gold Contract.** The all-inclusive uptime package.

To keep your truck on the road making money, there's the Volvo Gold Contract – an off-the-shelf service package. It includes service and repairs. It includes preventive maintenance. And it includes Service Planning and Features Online, two truly ground-breaking service features made possible by the TGW (Telematics Gateway).

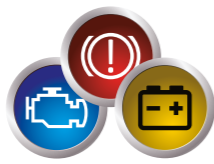

### **Service Planning.** One step ahead.

Thanks to the Telematics Gateway, the workshop can access information such as engine data, mileage, fuel consumption, diagnostic trouble codes, driving conditions and status of crucial components (brake pads, clutch, battery, air dryer etc.). That means we can alert you in time, before you risk an unplanned stop. But most importantly, we're always perfectly prepared when you enter the workshop. So you'll be back on the road before you know it.



### **Features Online.** Your wireless technician.

Some things shouldn't require a workshop visit. And now they don't. With Features Online, a service technician can access your vehicle remotely to calibrate displayed fuel consumption, fuel tank size (if you've fitted extra tanks) and your preferred road speed limit. It's even possible to enable the load indicator function from a distance. All you have to do is stop at the roadside for a short while. Service has never been quicker.



### **Need help?** Just push the button.

An unplanned stop out in the middle of nowhere? Volvo Action Service with On Call is just a button push away. It automatically connects you to an operator who speaks your language (the truck checks the nationality of the card in the digital tachograph). Once connected, service is both fast and accurate, because they already know your chassis ID, position and possible diagnostic trouble codes.



## HEADLIGHTS

# The future ahead looks bright.

# So do the curves and corners.

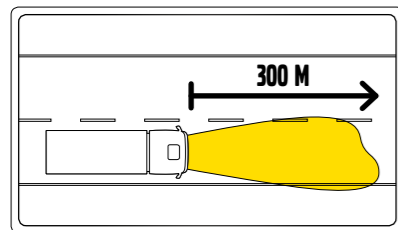

### Leading main beam.

When driving at night, Volvo FH is a particularly good friend. The headlights produce a powerful beam, providing you with an early view on what happens down the road. And, just as important, other road users will see you stand out in the dark.

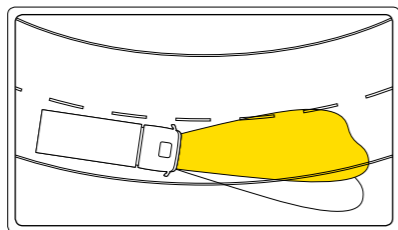

### Dynamic headlights.

With dynamic headlights, the dipped beam can pan to follow the road. Whenever you make a curve, so do the lights. On many stretches, this leads to a massively increased field of vision.

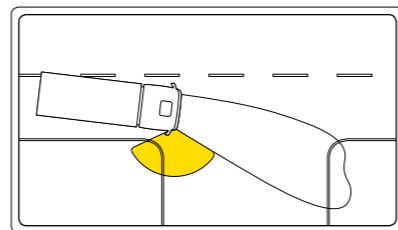

### Static cornering lights.

When you slow down to turn a corner in the dark, the enhanced static cornering lights come to your assistance. As soon as you activate the turn signal, the immediate area on the side lights up, helping you spot unprotected road users.



### Bi-Xenon.

Equip the headlamps with Bi-Xenon to experience a new level of brightness. They also offer longer service life compared with regular halogen lamps.

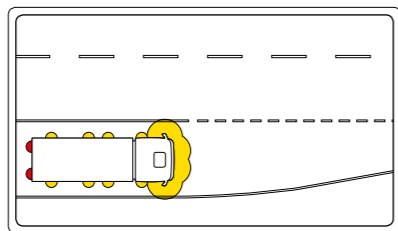

### Approach light.

When approaching the truck at night, just push the button on the remote key fob. The interior and exterior light up, letting you easily find and safely enter your truck. 🚚



### Characteristic look.

The V shaped position and daytime running lights gives the Volvo FH an impression that's easy to catch from a distance.

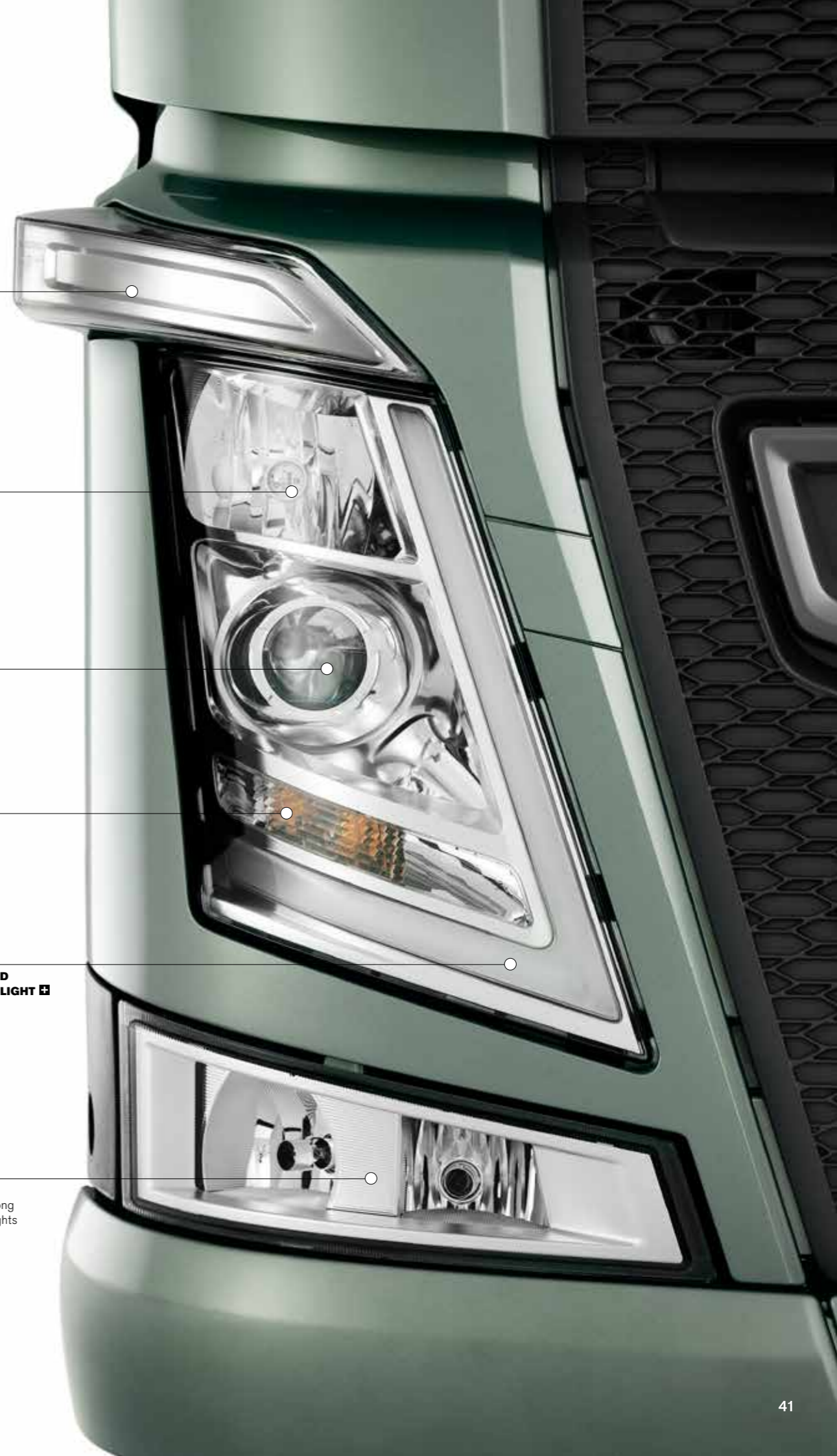

SIDE TURN INDICATOR

MAIN BEAM

DIPPED BEAM

TURN INDICATOR

POSITION LIGHT AND DAYTIME RUNNING LIGHT 🚚

AUXILIARY LAMPS  
Room for fog lights, along with static cornering lights or extra spotlights. 🚚

## LOAD HANDLING

# Keep a closer watch on the load. From afar.

The electronically controlled suspension (ECS) improves driving comfort and helps making sure the cargo travels safely. ECS4 is the latest version and has brought even more possibilities, with the Work Remote as the most prominent example. You now have perfect control, regardless of whether you're sitting behind the wheel or walking around the truck.



**5 levels for loading.  
3 for driving.  
All at your command.**

ECS includes four bellows per axle (two for pusher axles), providing a virtually parallel lift of the chassis. You can easily set the height you prefer. The system lets you store five different docking heights, something that comes in handy when you arrive at a familiar loading bay ramp. You can also choose from three customisable driving levels, to optimise ground clearance or aerodynamics. 



**Keeping the chassis steady.  
And the load in place.**

ECS steadily keeps the chassis level, regardless of how the cargo is distributed. It prevents sideways rolling, making sure the truck is always in balance. The Work Remote also allows you to manually compensate for side kneeling.



**Load indicator.  
Accurate and easy to overview.**

Intuitive menus and displays let you see exactly how the load is distributed along the vehicle. Weights, axle loads and bogie loads are all specified separately, so you can easily make sure they are within the limits, on the truck as well as on the trailer. Calibration is easy too. You can fine-tune both truck and trailer, for accurate measurements at all times. 



**Balance it all with your fingertips.**  
Cut the wire. With the Work Remote in your hand, you can control the air suspension manually while walking around freely.



**Control your equipment.**  
Start and stop the engine and up to four PTOs. You can also adjust engine speed, and store the rpm setting for quick access.



**Turn the lights on.**  
Do you have work lights, beacons or specific lights from the bodybuilder? Use the Work Remote to switch them on or off.



**Add functions from the bodybuilder.**  
Depending on superstructure, you can control several other functions. All are easily accessible through the menus, and can have the same icons as the buttons on the dashboard.



**Use it as a door key.**  
Yes, it is a bit bigger than the regular key fob, but still. It's quite convenient to be able to lock and unlock the cab doors without putting down the remote.



**Integrated tail lift controls.**  
No need to carry around two remote controls. The Work Remote allows you to conveniently raise and lower the tail lift.

**WORK REMOTE **

 Also available as an accessory.

# Keeping an extra eye on the road.

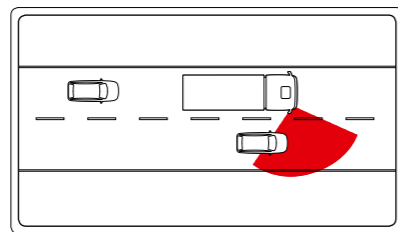

**Cornering camera.**  
Keep an eye on the hidden area on the passenger side of the truck. The cornering camera is activated when using the side turn indicator and displays the side view in the Secondary Information Display.

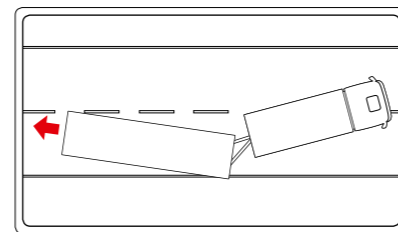

**Stretch Brake.**  
In certain situations, such as turning or driving downhill on a slippery road, the trailer risks catching up with the truck, creating a hazardous jack-knife effect. The Stretch Brake is a Volvo feature, designed to stop that from happening. By pulse braking the trailer, the vehicle combination is stretched, and the danger reduced. The system can be automatically activated in risky situations, at speeds up to 50 km/h.

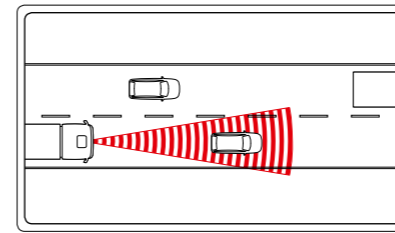

**Adaptive Cruise Control, collision warning and emergency brake.**  
Follow the traffic rhythm without effort. The radar-based Adaptive Cruise Control (ACC) keeps a safe distance to the vehicle in front by controlling the accelerator and all available brakes. If there's a risk of collision, warning lights are projected on the windscreen – and if an impact is imminent, the automatic emergency brake quickly comes to your assistance.

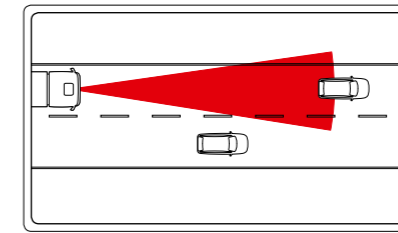

**Lane Keeping Support.**  
Drifting off lane is a common cause of serious accidents. Too common, we think. Lane Keeping Support tracks the road markings with a camera, and alerts you if you should unintentionally cross them.

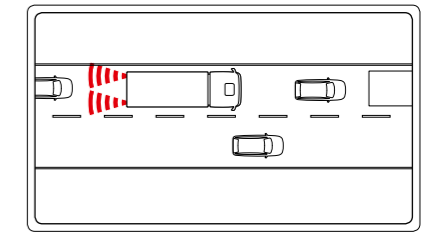

**Emergency brake light.**  
If you slam on the brakes, the brake lights flashes rapidly to alert the vehicles behind you. An easy way of avoiding rear-end collisions, which can be fatal and lead to major pile-ups. 🚚

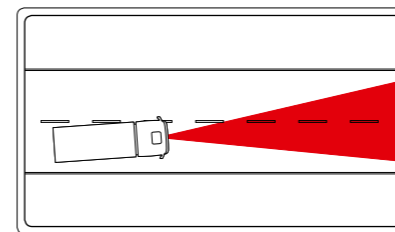

**Driver Alert Support.**  
Driver Alert Support is an intelligent system that tracks your driving behaviour. If it differs from normal and indicates tiredness, you are alerted by a signal and a message in the display, advising you to take a break. 🚚

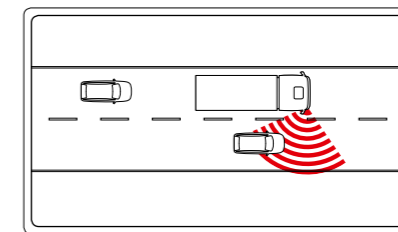

**Lane Changing Support.**  
The blind-spot area on the passenger side can easily hide other road users. Lane Changing Support is equipped with a radar that checks that area when you activate the turn signal. If the area's not clear, you are notified by a sound and a flashing icon by the mirror.

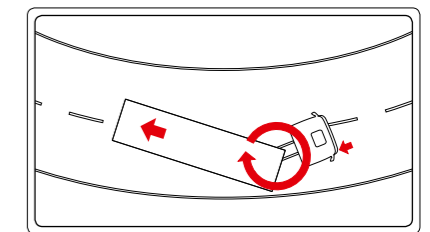

**Electronic Stability Program.**  
Volvo's Electronic Stability Program (ESP) efficiently reduces the risk of skidding and rollovers. In risky situations it instantly steps in, reducing engine power and braking the truck and trailer. Each wheel of the truck is braked individually. ESP is now available for most truck specifications, both tractors and rigs. 🚚

🚚 Also available as an accessory.



## SPECIFICATIONS

# Tailoring your Volvo FH.

This is just a hint of all the choices you have when tailoring your Volvo FH to your needs. The full specifications and all possible options are available at [www.volvotrucks.com](http://www.volvotrucks.com) or at your Volvo dealer.

### Cabs

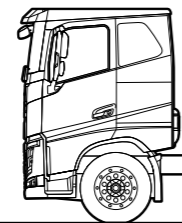
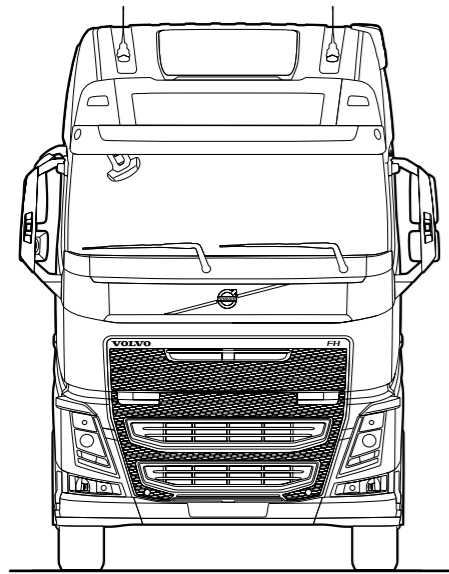

Low sleeper cab



Sleeper cab

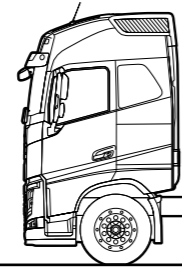

Globetrotter cab

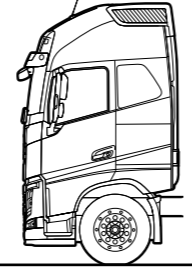

Globetrotter XL cab

### Tractor axle configurations



### Rigid axle configurations



● = Drive axle.  
○ = Dead axle (tag, pusher or front axle).

### Engines

| 13 LITRE                | Max power                 | Max torque                 |
|-------------------------|---------------------------|----------------------------|
| <b>EURO 3</b>           |                           |                            |
| <b>D13A400</b> (294 kW) | 400 hp at 1400–1800 r/min | 2000 Nm at 1050–1400 r/min |
| <b>D13A440</b> (324 kW) | 440 hp at 1400–1800 r/min | 2200 Nm at 1050–1400 r/min |
| <b>D13A480</b> (353 kW) | 480 hp at 1400–1800 r/min | 2400 Nm at 1050–1400 r/min |
| <b>D13A520</b> (382 kW) | 520 hp at 1500–1800 r/min | 2400 Nm at 1050–1450 r/min |
| <b>EURO 4</b>           |                           |                            |
| <b>D13A420</b> (309 kW) | 420 hp at 1400–1900 r/min | 2100 Nm at 1000–1400 r/min |
| <b>D13A460</b> (338 kW) | 460 hp at 1400–1900 r/min | 2300 Nm at 1000–1400 r/min |
| <b>D13A500</b> (368 kW) | 500 hp at 1400–1900 r/min | 2500 Nm at 1050–1400 r/min |
| <b>D13A540</b> (397 kW) | 540 hp at 1450–1900 r/min | 2600 Nm at 1050–1450 r/min |
| <b>EURO 5</b>           |                           |                            |
| <b>D13C420</b> (309 kW) | 420 hp at 1400–1900 r/min | 2100 Nm at 1000–1400 r/min |
| <b>D13C460</b> (338 kW) | 460 hp at 1400–1900 r/min | 2300 Nm at 1000–1400 r/min |
| <b>D13C500</b> (368 kW) | 500 hp at 1400–1900 r/min | 2500 Nm at 1050–1400 r/min |
| <b>D13C540</b> (397 kW) | 540 hp at 1450–1900 r/min | 2600 Nm at 1050–1450 r/min |

### Gearboxes

#### I-SHIFT

12-speed splitter and range gearbox with automated gearchanging system. The version with crawler gears facilitates easy operation with GCW up to 325 tonnes.

| Type     | Top gear  | Engine torque (Nm) | GCW approval (tonnes) |
|----------|-----------|--------------------|-----------------------|
| AT2412F  | Direct    | 2400               | 44                    |
| AT2612F  | Direct    | 2600               | 60                    |
| ATO2612F | Overdrive | 2600               | 60                    |

#### MANUAL GEARBOXES

14-speed splitter and range manual gearbox with two crawler gears. Short and distinct gear settings with low gearchanging forces.

| Type     | Top gear  | Engine torque (Nm) | GCW approval (tonnes) |
|----------|-----------|--------------------|-----------------------|
| VT2214B  | Direct    | 2200               | 100                   |
| VTO2214B | Overdrive | 2200               | 100                   |
| VT2514B  | Direct    | 2500               | 100                   |
| VTO2514B | Overdrive | 2500               | 100                   |
| VT2814B  | Direct    | 2800               | 100                   |
| VTO2814B | Direct    | 2800               | 100                   |

Here's a small selection of specifications – but there are more to choose from. Ask your Volvo dealer or visit [www.volvotrucks.com](http://www.volvotrucks.com) to learn more.



## ACCESSORIES

# Make it your truck.

The Volvo FH is one of the most well equipped trucks in the world. But to tailor it for your particular transport assignments and for your personal needs, there's also a wide range of accessories to choose from. It's all about making the truck more efficient for the work you do. And don't forget that they are all developed and tested by Volvo Trucks for Volvo trucks to make sure they all bring what you expect from a Volvo product. Hey, we've even crash tested the coffee maker!

Here's a small selection of accessories – but there are tonnes more to choose from. Ask your Volvo dealer or visit [www.volvotrucks.com](http://www.volvotrucks.com) to learn more about accessories.



Daytime running light



Stainless steel wheel cover



Flashing LED warning light



Air blow gun



Alcolock



Coffee maker



Exterior water tank



Red seat belt



Cradle plate for phone

Some of the equipment shown or mentioned may only be available as options or accessories and may vary from one country to another in accordance with local legislation. Your Volvo dealer will be happy to provide you with more detailed information. Colours may vary somewhat owing to the limitations of the printing process. We reserve the right to alter product specifications without prior notification.

**VOLVO**

Volvo Truck Corporation  
[volvotrucks.com](http://volvotrucks.com)